

KL4N3X PHOTO TRANSISTOR

DIP6 晶体管光耦

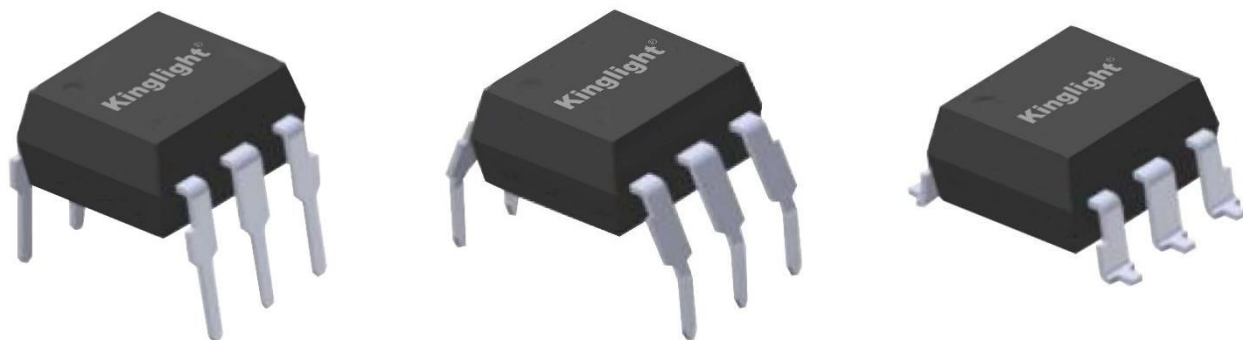

* 本文档中包含的信息反映了具有代表性的使用场景，仅供技术参考。

The information contained in this document reflects representative usage scenarios and is intended for technical reference only.

* 本文档中提到的产品型号和规格如有更改或改进，恕不另行通知。在生产使用之前，客户应参考产品规格书的最新数据表。

Product models and specifications mentioned in this document are subject to change or improvement without notice. Customers should refer to the latest data sheets in the product specifications prior to production use.

* 在使用本文档中引用的产品时，请确保产品在数据手册中规定的环境和电气限制范围内运行。如果客户使用超过指定的限制，晶台将不会对任何后续问题负责。

When using the products referenced in this document, ensure that the products are operated within the environmental and electrical limits specified in the data sheet. If the customer uses the product beyond the specified limits, Kinglight will not be responsible for any subsequent problems.

* 本文档中的信息适用于电子元器件应用中的典型用法。如有任何特殊用途，请向晶台咨询，以获得进一步的帮助。

The information in this document applies to typical use in electronic component applications. For special applications, please contact Kinglight for further assistance.

* 未经晶台允许，不得复制或转载本文件的内容和信息。对于最新的信息，请参考官方网站 [Http://www.kinglight-OC.com](http://www.kinglight-OC.com)。

The contents and information in this document may not be copied or reproduced without the permission of Kinglight. For the latest information, please visit the official website [Http://www.kinglight-OC.com](http://www.kinglight-OC.com).

1. 产品特点 Product features

- 4N3X系列: 4N35、4N36、4N37、4N38 (4N3X series: 4N35, 4N36, 4N37, 4N38)
- 输入与输出间高隔离电压(Viso=5000 V rms)
High isolation voltage between input and output (Viso=5000 V rms)
- 爬电距离>7.62mm (Creepage distance > 7.62mm)
- 工作温度可达+110°C (Operating temperature up to +110°C)
- 紧凑型双列直插式封装 Compact dual-in-line package
- 符合欧盟REACH法规 Compliance with EU REACH
- 无Pb且符合ROHS标准 Pb free and RoHS compliant

2. 产品描述 Product Description

- KL4N3X系列器件由一个红外发射二极管与一个光电晶体管组合，构成光电耦合器。
The KL4N3X series of devices each consist of an infrared emitting diode optically coupled to a phototransistor.
- 它们采用6引脚DIP封装，并提供宽引线间距和SMD选项。
They are packaged in a 6-pin DIP package and available in wide-lead spacing and SMD option.

3. 产品应用 Product Applications

- 电源调节器 Power supply regulators
- 数字逻辑输入 Digital logic inputs
- 微处理器输入 Microprocessor inputs

4. 功能图 Functional Diagram

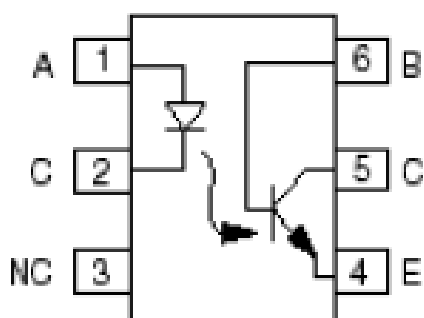

引脚配置 Pin Configuration

1. 阳极 Anode
2. 阴极 Cathode
3. 无连线 No Connection
4. 发射极 Emitter
5. 集电极 Collector
6. 基极 Base

5. 光电特性 Electrical-Optical characteristics

• 最大限度额定值(温度=25°C) Absolute Maximum Ratings(Ta=25°C)

参数 Parameter		符号 Symbol	额定值 Rated Value	单位 Unit
输入 Input	正向电流 Forward current	I_F	60	mA
	峰值正向电压(t = 10μs) Peak forward current (t = 10μs)	I_{FM}	1	A
	反向电压 Reverse voltage	V_R	6	V
	功耗(Ta=25°C) Power dissipation (Ta=25°C)	P_D	100	mW
	降额系数(高于100°C) Derating factor (above 100°C)		3.8	mW/°C
输出 Output	集电极-发射极电压 Collector-Emitter voltage	V_{CEO}	80	V
	集电极-基极电压 Collector-Base voltage	V_{CBO}	80	V
	发射极-集电极电压 Emitter-Collector voltage	V_{ECO}	7	V
	发射极-基极电压 Emitter-Base voltage	V_{EBO}	7	V
	输出功率(Ta=25°C) Output Power dissipation (Ta=25°C)	P_c	150	mW
	降额系数 (高于100°C) Derating factor (above 100°C)		9.0	mW/°C
	总消耗功率 Total Power dissipation		P_{TOT}	200
隔离电压 (1*) Isolation Voltage		V_{ISO}	5000	Vrms
工作温度 Operating temperature		T_{OPR}	-55 to +110	°C
储存温度 Storage temperature		T_{STG}	-55 to +125	°C
焊接温度 (2*) Soldering temperature		T_{SOL}	260	°C

附注 (Notes):

1* 交流电源1分钟内, 相对湿度在40~60%RH环境下, 隔离电压测试时, 1&2&3脚短接, 4&5&6脚短接
AC for 1 minute, R.H.= 40 ~ 60% R.H. In this test, pins 1, 2 & 3 are shorted together, and pins 4, 5 & 6 are shorted together.

2* 焊接时间为10秒 Soldering time is 10 seconds

6. 电气特性(Ta=25°C,除非另有规定)

Electrical Characteristics(Ta=25°C unless specified otherwise)

参数 Parameter		符号 Symbol	最小值 Min.	规格值 Typ.	最大值 Max.	单位 Unit	条件 Condition
输入 Input	正向电压 Forward voltage	V_F	-	1.2	1.5	V	$I_F = 10\text{mA}$
	反向电流 Reverse current	I_R	-	-	10	μA	$V_R = 6\text{V}$
	输入电容 Input capacitance	C_{in}	-	30	-	pF	$V = 0,$ $f = 1\text{MHz}$
输出 Output	集电极-基极暗电流 Collector-Base dark current	I_{CBO}	-	-	20	nA	$V_{CB} = 10\text{V}$
	集电极-发射极暗电流 Collector-Emitter dark current	I_{CEO}	-	-	50	nA	$V_{CE} = 60\text{V},$ $I_F = 0\text{mA}$
	集电极-发射极击穿电压 Collector-Emitter breakdown voltage	V_{CEO}	80	-	-	V	$I_C = 1\text{mA}$
	集电极-基极击穿电压 Collector-Base breakdown voltage	V_{CBO}	80	-	-	V	$I_C = 0.1\text{mA}$
	发射极-集电极击穿电压 Emitter-Collector breakdown voltage	V_{ECO}	7	-	-	V	$I_E = 0.1\text{mA}$
	发射极-基极击穿电压 Emitter-Base breakdown voltage	V_{EBO}	7	-	-	V	$I_E = 0.1\text{mA}$
	集电极-发射极电容 Collector-Emitter capacitance	C_{CE}	-	8	-	pF	$V_{CE} = 0\text{V},$ $f = 1\text{MHz}$

• 附注(Notes):

1*. Ta=25°C时的规格值 Typical values at Ta = 25°C

- 传输特性 (Ta=25°C, 除非另有规定)

Transfer Characteristics (Ta=25°C unless specified otherwise)

参数 Parameter		符号 Symbol	最小值 Min.	规格值 Typ.	最大值 Max.	单位 Unit	条件 Condition
电流传输比 Current transfer ratio	4N35, 4N36, 4N37	CTR	100	-	-	%	I _F = 10mA V _{CE} = 10V
	4N38		20				
集电极与发射极间饱和电 压 Collector-Emitter saturation voltage	4N35, 4N36, 4N37	V _{CE(sat)}	-	-	0.3	V	I _F = 10mA I _C = 0.5mA
	4N38				1.0		
隔离电阻 Isolation resistance		R _{ISO}	10 ¹¹	-	-	Ω	V _{IO} = 500Vdc
输入-输出电容 Input-output capacitance		C _{IO}	-	0.2	-	pF	V _{IO} = 0, f= 1MHz
启用时间 Turn-on time		T _{on}	-	10	12	μs	V _{CC} = 10V, I _F = 2mA, R _L = 100Ω See Fig.11
关断时间 Turn-off time		T _{off}		9			

- 附注(Notes):

1*. Ta=25°C时的规格值 Typical values at Ta = 25°C

7. 可靠性试验 Reliability Test

序号 NO.	试验项目 Test Items	参考标准 Reference	试验条件 Test conditions	试验过程 Test process	试验数 Qty.(pcs)	允收水准 LTPD
1	温度循环 TC	JESD22-A104C	H:125±5°C 15min J 5min L:-55±5°C 15min	300cycle	45	0/45
2	高温操作寿命 HTOL	JESD22-A108C	HTOL@110±5°C I _f =10mA I _c =10mA	168、500、 1000hrs	45	0/45
3	高温反向偏压 HTRB	JESD22-A108C	HTRB@125±5°C V _{ce} =60V	168、500、 1000hrs	45	0/45
4	温湿度反向偏 压寿命试验 H3TRB	JESD22-A101- B	H3TRB@ 85±5°C、 85±5%RH V _{ce} =60V	168、500、 1000hrs	45	0/45
5	压力锅 Autoclave	JESD22-A102- C	T _a =121±5°C, 100±5%RH, 2atm	96hrs	45	0/45
6	高温储存 HTS	JESD22-A103C	HTS@125±5°C	168、500、 1000hrs	45	0/45
7	低温储存 LTS	JESD22-A119	LTS@-55±5°C	168、500、 1000hrs	45	0/45
8	耐锡热试验 RSH	JESD22-B106C	RSH@260±5°C	10sec*3times	45	0/45
9	可焊性 SD	JESD22-B102D	Pb-free@ 245±5°C	3sec*1times	22	0/22
备注 Remarks	以上试验项目如与客户试验要求存在差异或者特殊客户特殊要求的,可根据实际情况按照客户的要求进行试 作,客户未要求依我司试验标准试作,不同产品使用不同电流进行测试 All the tests should be performed according to customers' actual requirements, while difference of test standard or special requirements exist. Otherwise, all the tests are performed according to the standard listed above. Different current is applied to the tests of different product models					

8. 特性曲线 Characteristic Curves

图1 正向电流与正向电压的关系

Figure 1. Forward Current vs Forward Voltage



图2 电流传输比与正向电流的关系

Figure 2. Current Transfer vs Forward Current

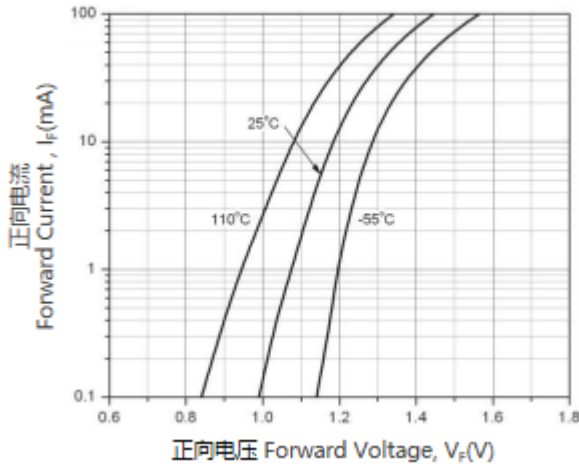

图3 电流传输比与环境温度的关系

Figure 3. Current Transfer Ratio vs Ambient Temperature

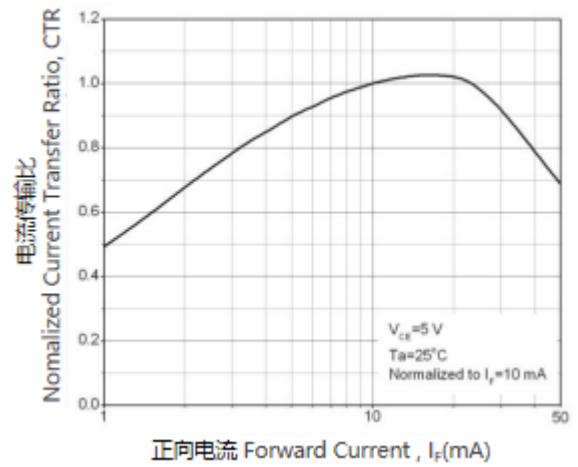

图4 电流传输比(饱和)与基极-发射极电阻的关系

Figure 4. Current Transfer Ratio (Saturated) vs Base-Emitter Resistance

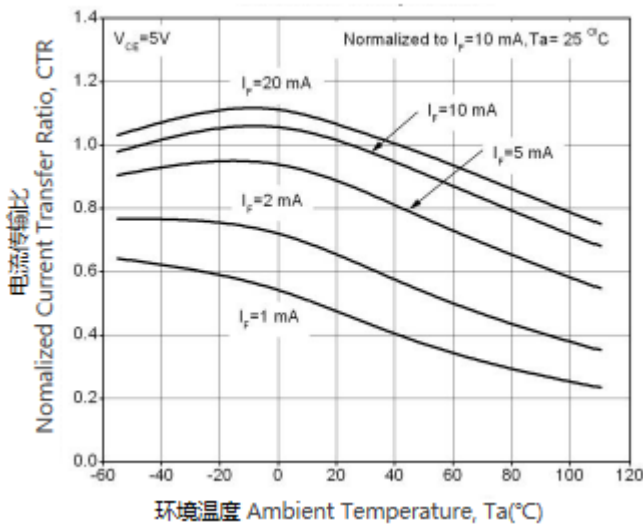

图5 电流传输比(不饱和)与基极-发射极电阻的关系

Figure 5. Current Transfer Ratio (Unsaturated) vs Base-Emitter Resistance

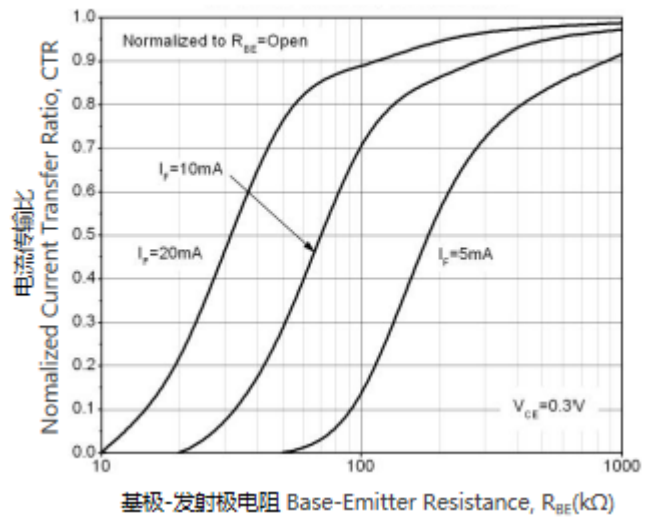

图6 暗电流与环境温度的关系

Figure 6. Dark Current vs Ambient Temperature



图7 集电极-发射极饱和电压与集电极电流的关系
Figure 7. Collector-Emitter Saturation Voltage vs Collector Current

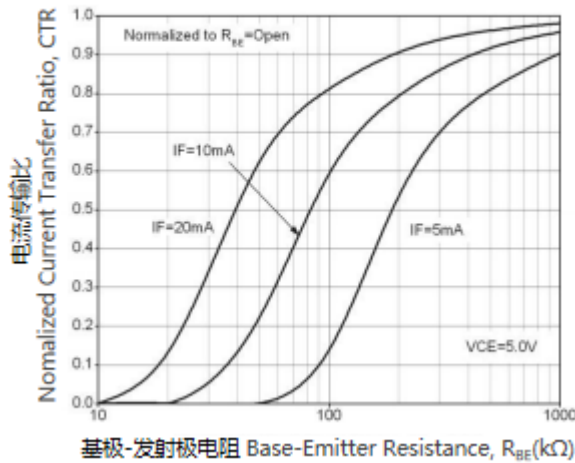

图8 开关时间与负载电阻的关系
Figure 8. Switching Time vs Load Resistance

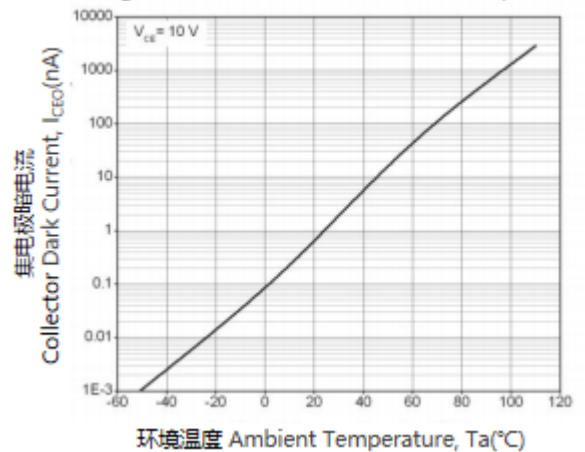

图9 启用时间与基极-发射极电阻的关系
Figure 9. Turn-on Time vs Base-Emitter Resistance

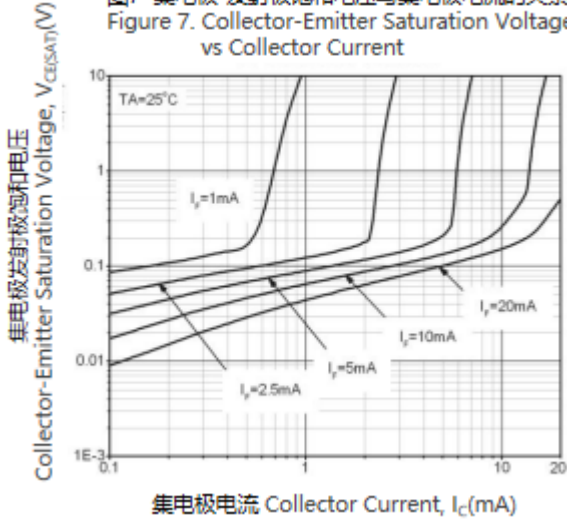

图10 关断时间与基极-发射极电阻的关系
Figure 10. Turn-off Time vs Base-Emitter Resistance

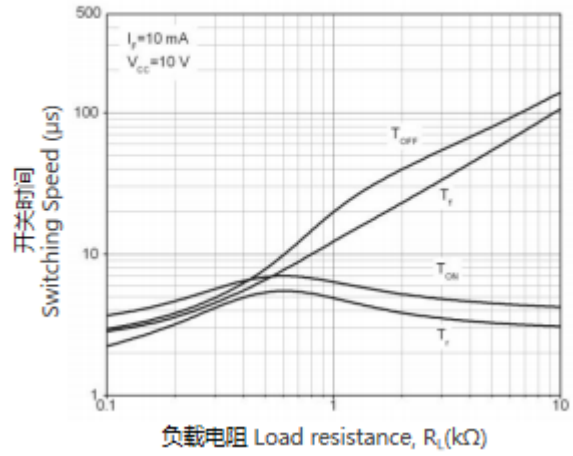

图11 开关时间测试电路&波形
Figure 11. Switching Time Test Circuit & Waveforms

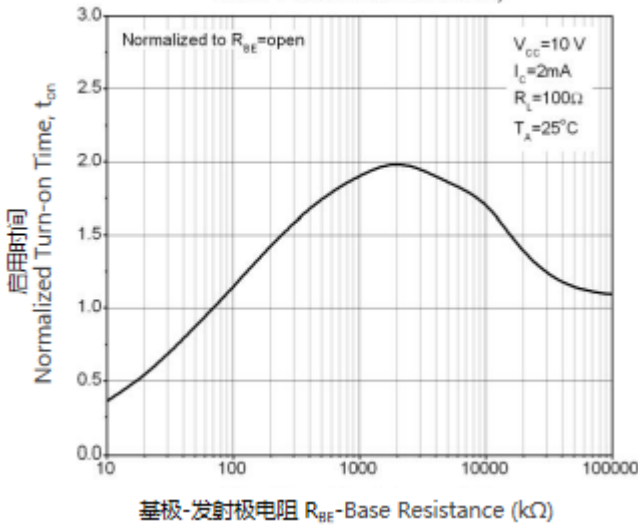

9. 订单信息 Order Information

- 材料编号 Part Number

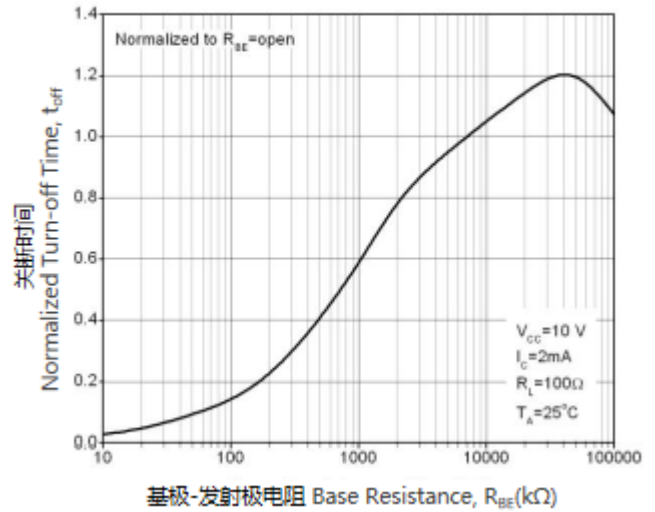
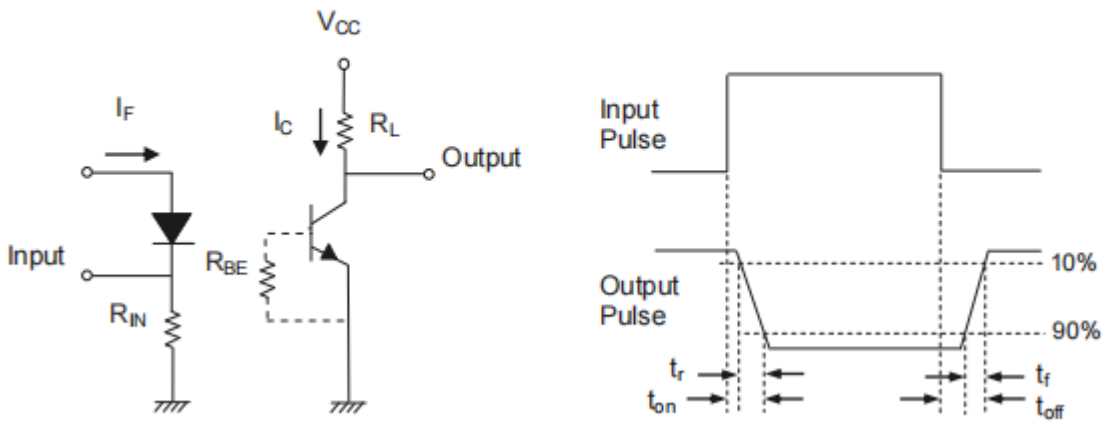
KL4N3X-YZ-V

附注(Notes):

- X = 4N3X系列零件编号(5、6、7 或 8)
Part No. for 4N3X series(5, 6, 7 or 8)
- Y = 引脚形式选项(S、S1、M 或 无)
Lead form option (S, S1, M or none)
- Z = 料带和卷轴选项(TA、TB 或 无)
Tape and reel option (TA, TB or none)
- V = 表示VDE标识(客户指定镭射字符才加"V")
VDE (Only add "V" to laser characters specified by the customer)

选项 Option	描述 Description	包装数量 Packing quantity
无 None	标准DIP-6 Standard DIP-6	每管65pcs 65 units per tube
M	宽引脚弯曲(0.4英寸间距) Wide lead bend (0.4 inch spacing)	每管65pcs 65 units per tube
S (TA)	表面贴装引线形式+TA载带和卷轴选项 Surface mount lead form + TA tape & reel option	每卷1000pcs 1000 units per reel
S (TB)	表面贴装引线形式+TB载带和卷轴选项 Surface mount lead form + TB tape & reel option	每卷1000pcs 1000 units per reel
S1 (TA)	表面贴装引线形式(低剖面)+TA载带和卷轴选项 Surface mount lead form (low profile) + TA tape & reel option	每卷1000pcs 1000 units per reel
S1 (TB)	表面贴装引线形式(低剖面)+TB载带和卷轴选项 Surface mount lead form (low profile) + TB tape & reel option	每卷1000pcs 1000 units per reel

10. 封装尺寸(单位:毫米) Package Drawing(Unit:mm)

- 标准DIP型号 Standard DIP Type

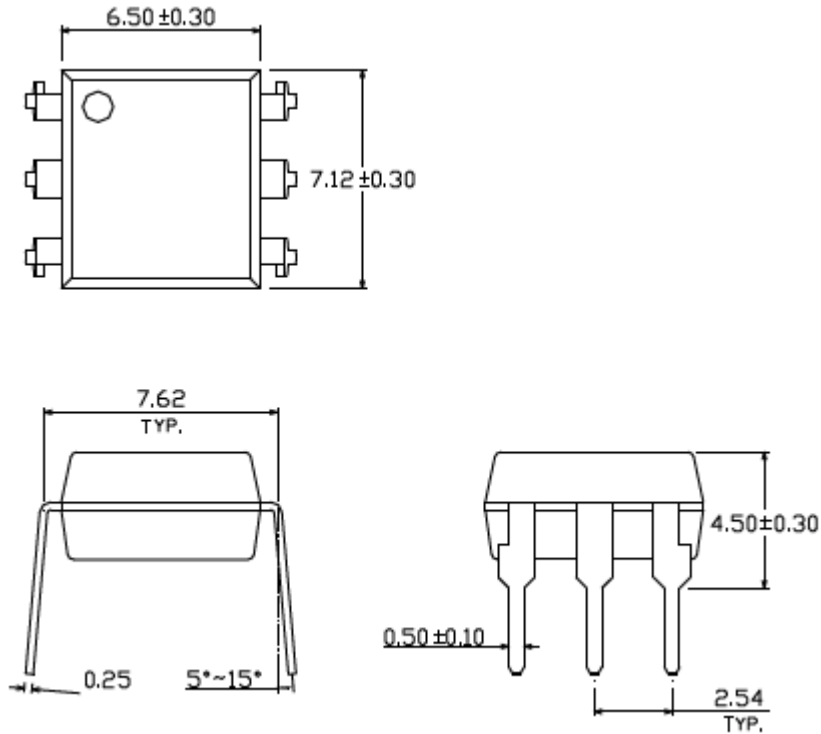

- 选择M型号 Option M Type

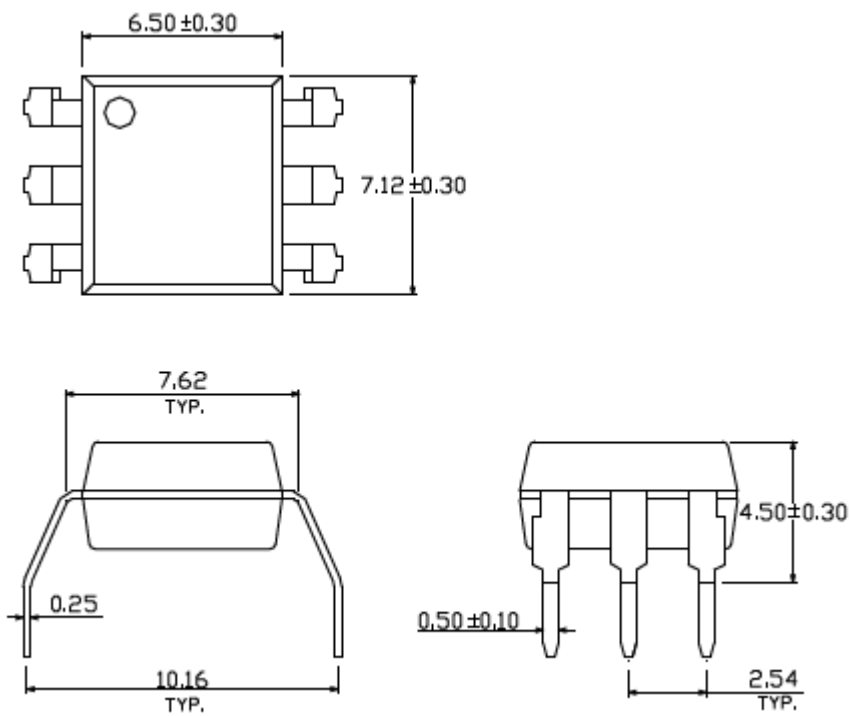

• 选择S型号 Option S Type

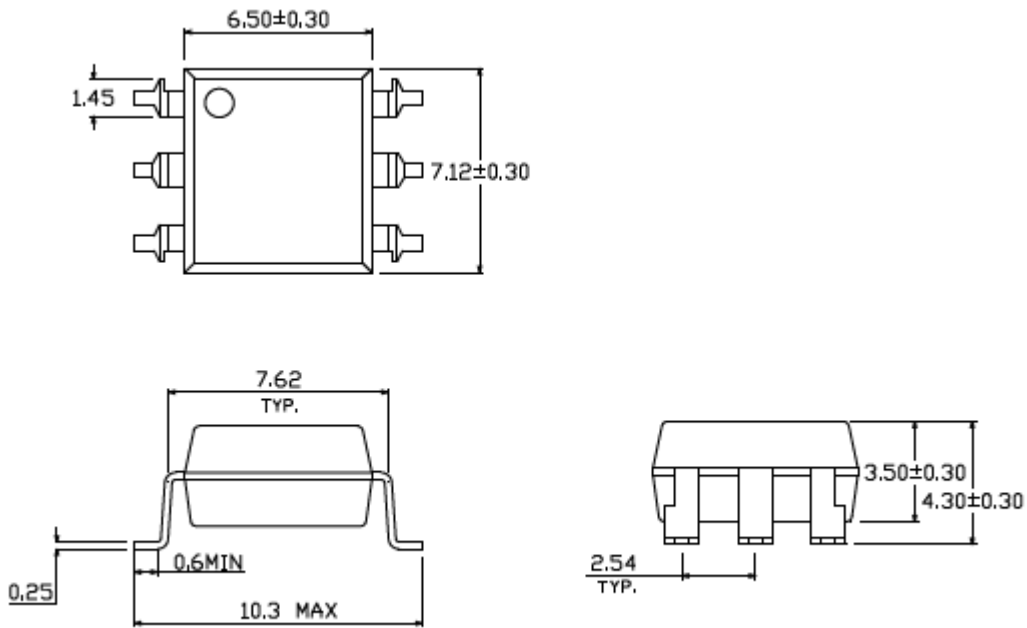

• 选择S1型号 Option S1 Type

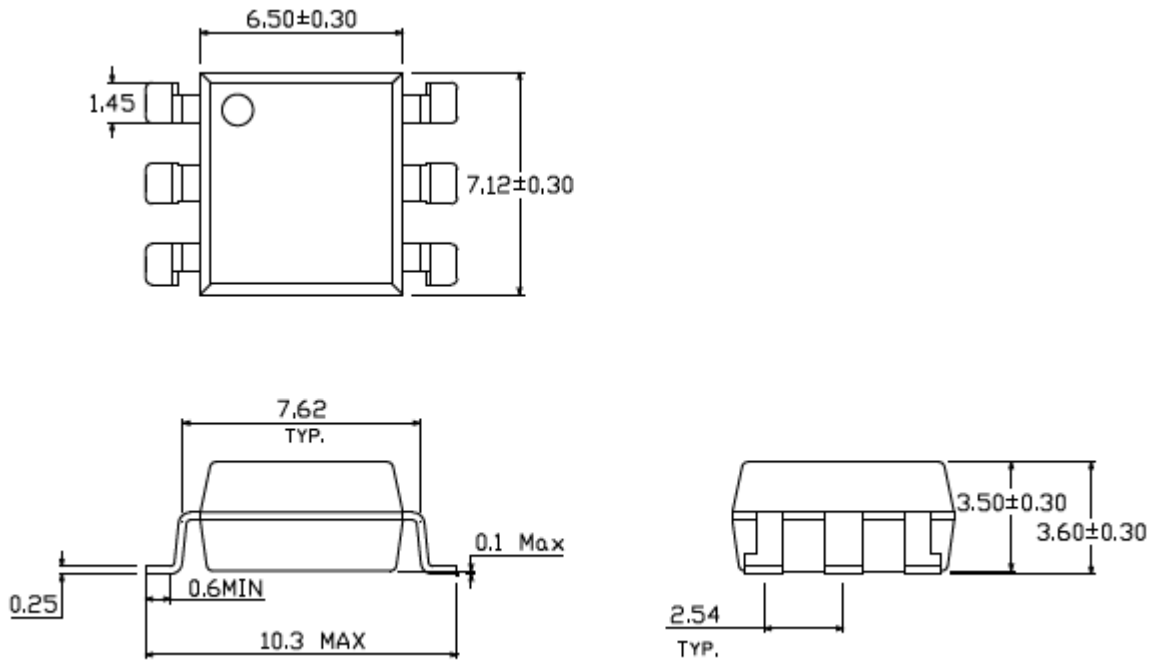

- 表面贴片类型PIN脚焊盘布局 Surface patch type PIN foot pad layout

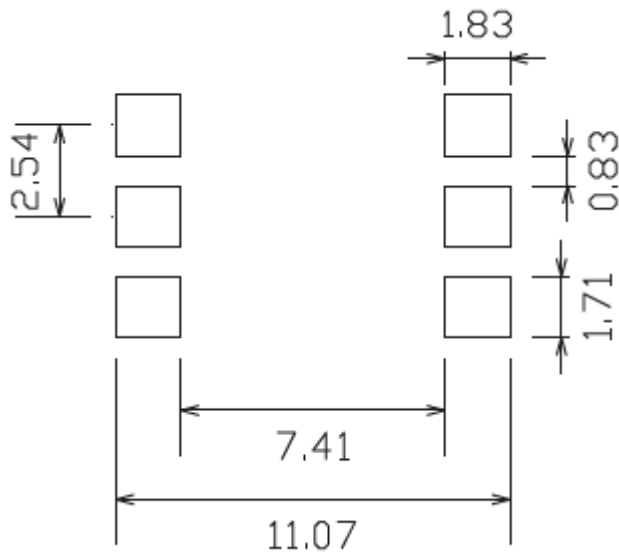

附注(Notes):

- 推荐焊盘尺寸仅供参考 Suggested pad dimension is just for reference only
- 请根据个人需要修改焊盘尺寸 Please modify the pad dimension based on individual need

11. 设备标记 Device marking

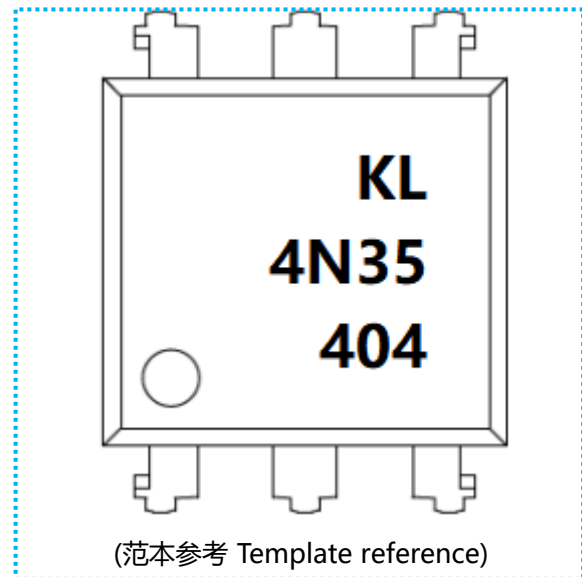
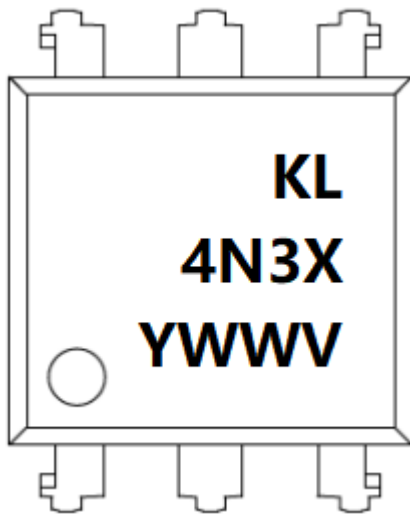

附注(Notes):

- KL = 表示晶台光电有限公司 Denotes KingLight
- 4N3X = 表示材料部件号 Denotes Device Part Number
X表示零件编号(5、6、7 或 8) Part No. (5, 6, 7 or 8)
- Y = 表示1位年份代码 Denotes 1 digit Year code
- WW = 表示2位周别代码 Denotes 2 digit Week code
- V = 表示VDE标识(客户指定镭射字符才加"V")
VDE (Only add "V" to laser characters specified by the customer)

12. 料带和卷轴包装规格 Tape & Reel Packing Specifications

• 选择TA Option TA

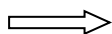
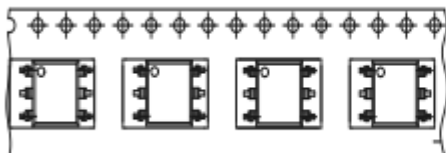

卷轴进给方向 Direction of feed from reel

• 选择TB Option TB

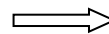
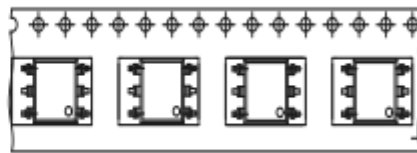

卷轴进给方向 Direction of feed from reel

料带尺寸 Material belt size

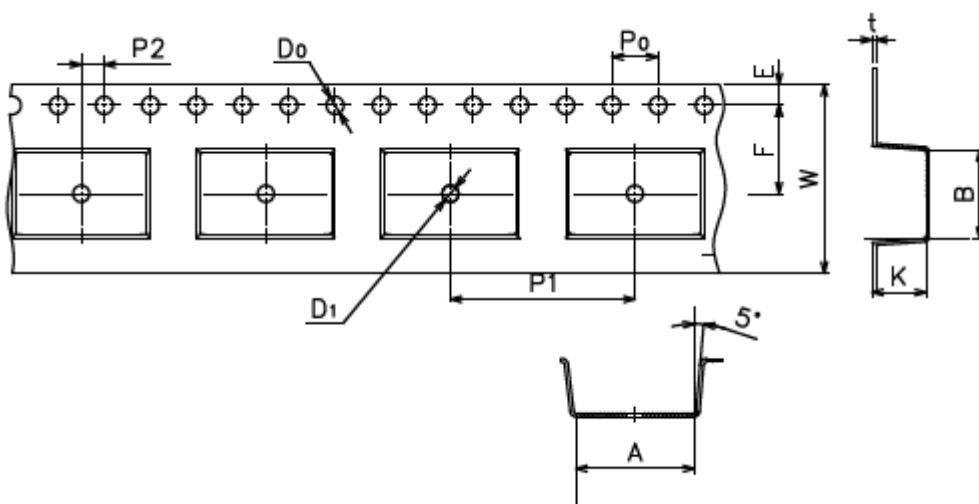

尺寸编号 Dimension No.	A	B	D0	D1	E	F
尺寸(mm) Dimension(mm)	10.8±0.1	7.55±0.1	1.5±0.1	1.5+0.1/-0	1.75±0.1	7.5±0.1
尺寸编号 Dimension No.	P0	P1	P2	t	W	K
尺寸(mm) Dimension(mm)	4.0±0.15	12.0±0.1	2.0±0.1	0.35±0.03	16.0±0.2	4.5±0.1

13. 焊接温度曲线 Temperature Profile Of Soldering

• 回流焊焊接条件 Reflow soldering Soldering Condition

建议在下面所示的温度和时间分布条件下, 进行一次回流焊作业, 不得超过三次

One time soldering reflow is recommended within the condition of temperature and time profile shown below. Do not solder more than three times.

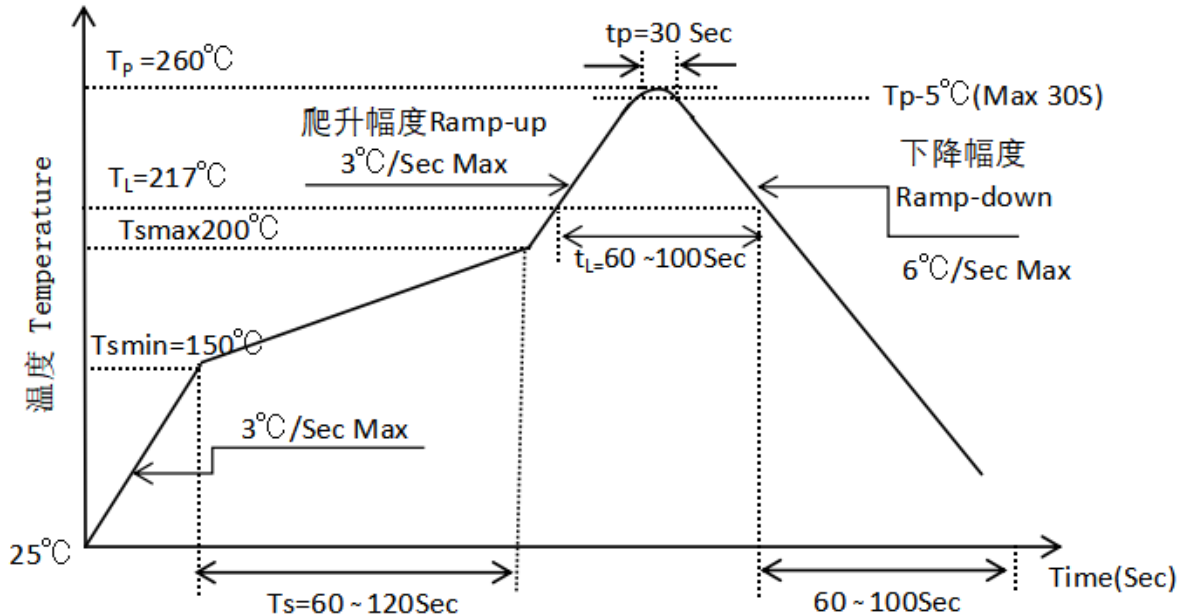

项目 Item	符号 Symbol	最小值 Min.	最大值 Max.	单位 Unit
预热温度 Preheat Temperature	T_s	150	200	°C
预热时间 Preheat Time	t_s	60	120	s
升温速率 Ramp-Up Rate (T_L to T_P)	-	-	3	°C/s
液相线温度 Liquidus Temperature	T_L	217		°C
高于液相线温度(T_L) 的时间 Time above Liquidus Temperature T_L	t_L	60	100	s
峰值温度 Peak Temperature	T_P	-	260	°C
T_c 在(T_P-5)和 T_P 之间的时间 Time During Which T_c Is Between (T_P-5) and T_P	t_p	-	30	s
降温速率 Ramp-down Rate(T_P to T_L)	-	-	6	°C/s

• 波峰焊温度曲线 Wave Soldering

温度条件下, 建议一次焊接

One time soldering is recommended within the condition of temperature

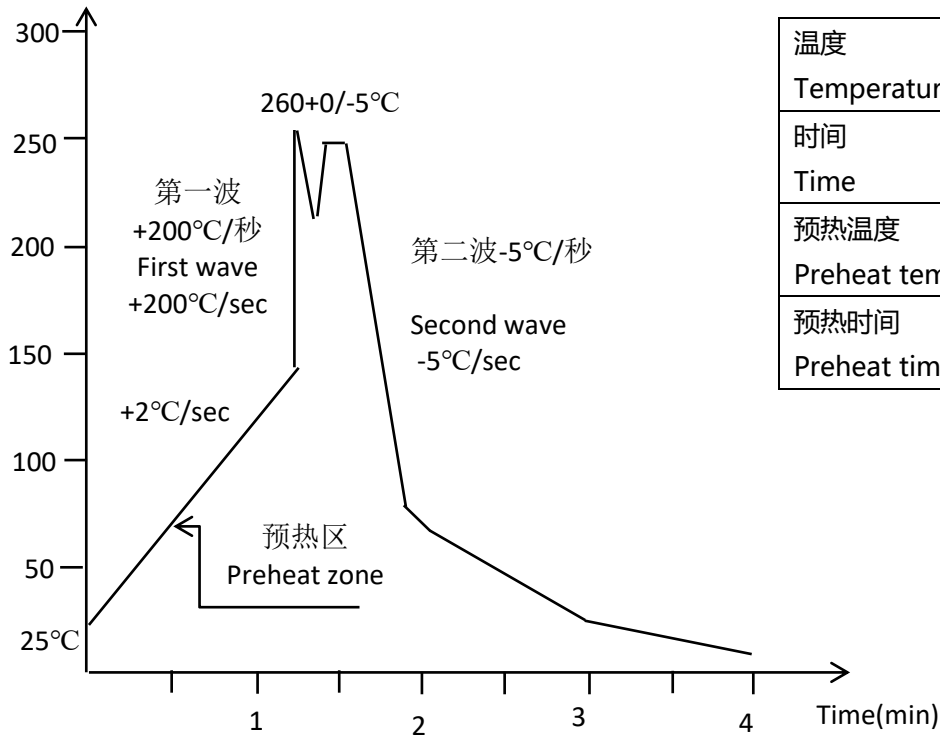

温度 Temperature	260°C+0/-5°C
时间 Time	10秒 10S
预热温度 Preheat temperature	25至140°C 25 to 140°C
预热时间 Preheat time	30至80秒 30 to 80 S